

SDD165N22B

Diode-Diode Modules

Holerance: ±0.5mm
Dimensions in mm (1mm=0.0394")

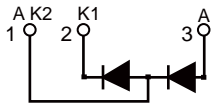

Type	V _{RSM} V	V _{RRM} V
SDD165N08B	900	800
SDD165N12B	1300	1200
SDD165N14B	1500	1400
SDD165N16B	1700	1600
SDD165N18B	1900	1800
SDD165N20B	2100	2000
SDD165N22B	2300	2200

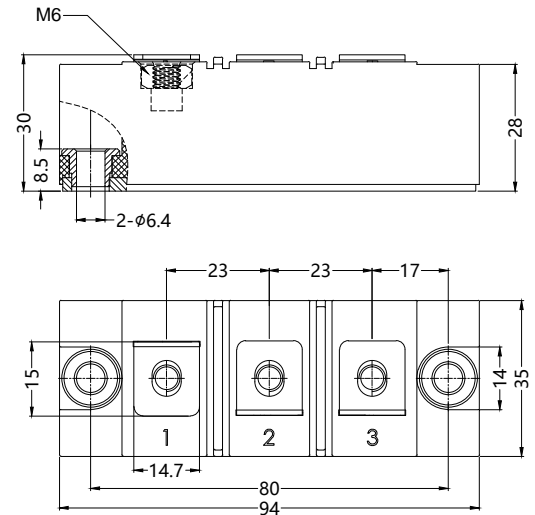

Symbol	Test Conditions	Maximum Ratings	Unit
I _{FRMS} I _{FAVM}	T _{VJ} =T _{VJM} T _C =100°C; 180° sine	300 165	A
I _{FSM}	T _{VJ} =45°C V _R =0 t=10ms (50Hz), sine t=8.3ms (60Hz), sine	4700 5000	A
	T _{VJ} =T _{VJM} V _R =0 t=10ms(50Hz), sine t=8.3ms(60Hz), sine	4100 4300	
∫i ² dt	T _{VJ} =45°C V _R =0 t=10ms (50Hz), sine t=8.3ms (60Hz), sine	110000 104000	A ² s
	T _{VJ} =T _{VJM} V _R =0 t=10ms(50Hz), sine t=8.3ms(60Hz), sine	84000 77000	
T _{VJ} T _{VJM} T _{stg}		-40...+150 150 -40...+125	°C
V _{ISOL}	50/60Hz, RMS I _{ISOL} ≤1mA t=1min t=1s	3000 3600	V~
M _d	Mounting torque (M6) Terminal connection torque (M6)	2.25-2.75/20-25 4.5-5.5/40-48	Nm/lb.in.
Weight	Typ.	177	g



Sirectifier[®]

SDD165N22B

Diode-Diode Modules

Symbol	Test Conditions	Characteristic Values	Unit
I_R	$T_{VJ}=T_{VJM}; V_R=V_{RRM}$	20	mA
V_F	$I_F=500A; T_{VJ}=25^{\circ}C$	1.35V(for 1800V) 1.75V for 2200V	V
V_{TO}	For power-loss calculations only	0.8	V
r_T	$T_{VJ}=T_{VJM}$	1.3	mΩ
Q_S	$T_{VJ}=125^{\circ}C; I_F=300A; -di/dt=50A/us$	550	μC
I_{RM}		235	A
R_{thJC}	per diode; DC current per module	0.21 0.105	K/W
R_{thJK}	per diode; DC current per module	0.31 0.155	K/W
d_S	Creepage distance on surface	12.7	mm
d_A	Strike distance through air	9.6	mm
a	Maximum allowable acceleration	50	m/s ²

FEATURES

- * International standard package
- * Copper base plate
- * Glass passivated chips
- * Isolation voltage 3600 V~
- * UL file NO.310749
- * RoHs compliant

APPLICATIONS

- * Supplies for DC power equipment
- * DC supply for PWM inverter
- * Field supply for DC motors
- * Battery DC power supplies

ADVANTAGES

- * Space and weight savings
- * Simple mounting
- * Improved temperature and power cycling
- * Reduced protection circuits

SDD165N22B

Diode-Diode Modules

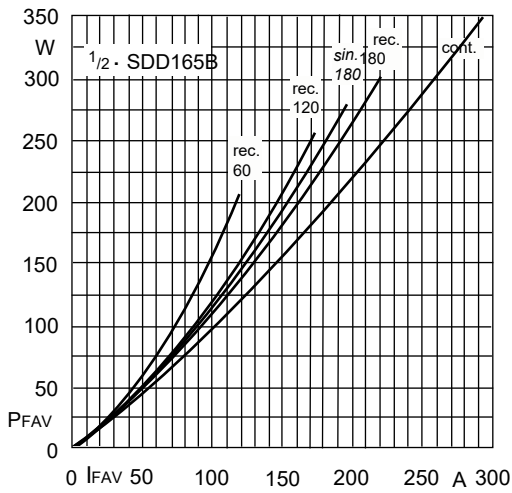

Fig. 11L Power dissipation per diode vs. forward current

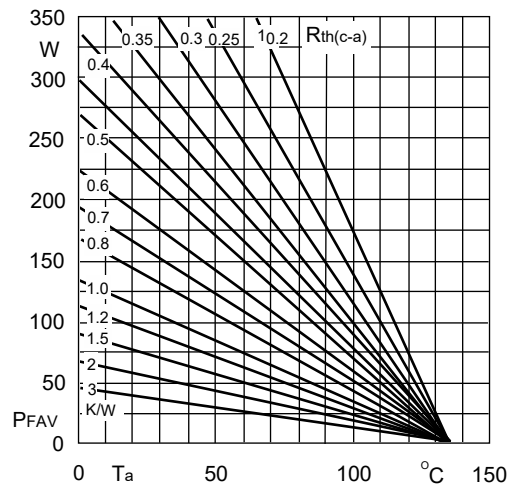

Fig. 11R Power dissipation per diode vs. ambient temperature

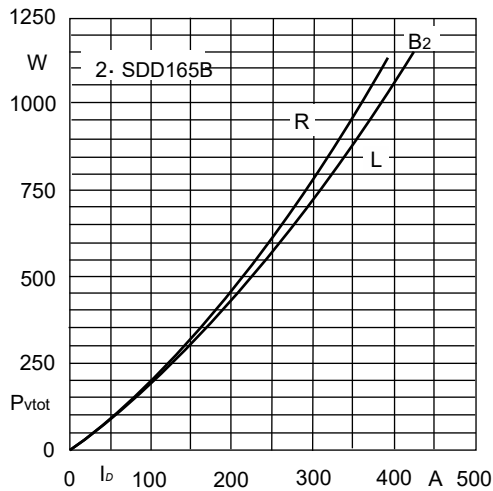

Fig. 12L Power dissipation of two modules vs. direct current

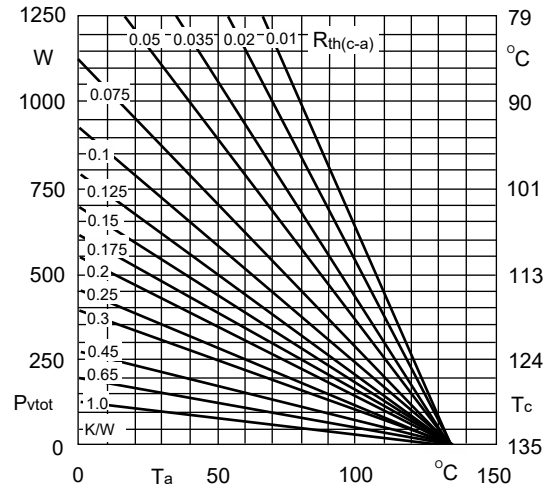

Fig. 12R Power dissipation of two modules vs. case temperature

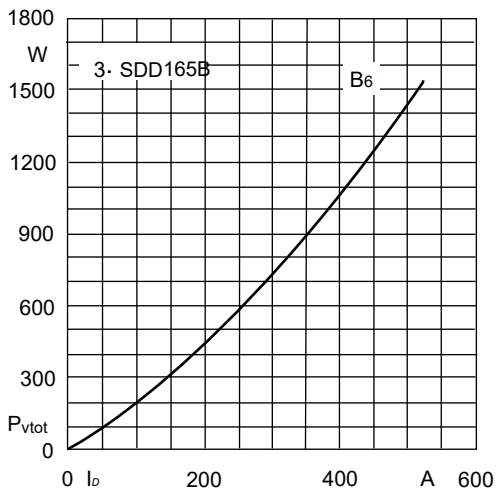

Fig. 13L Power dissipation of three modules vs. direct current

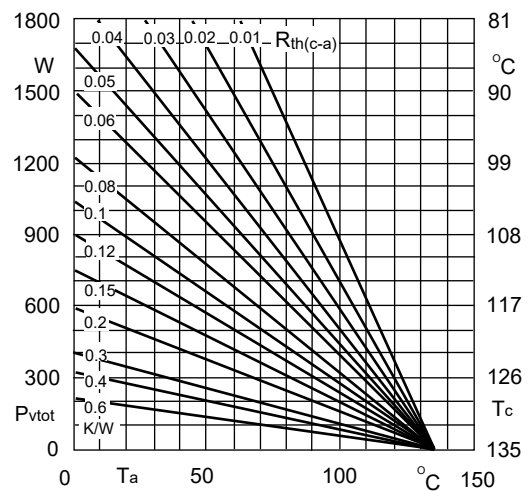

Fig. 13R Power dissipation of three modules vs. case temperature

SDD165N22B

Diode-Diode Modules

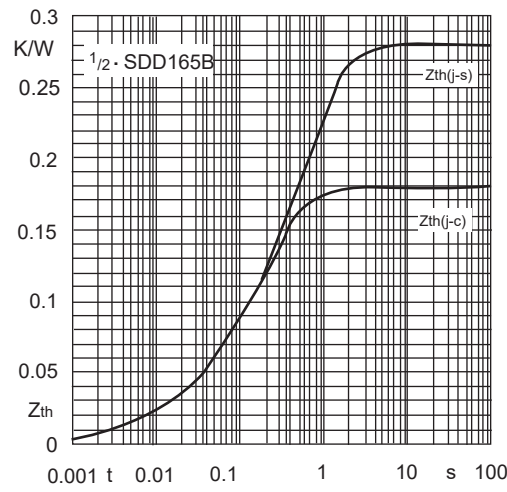

Fig.14 Transient thermal impedance vs. time

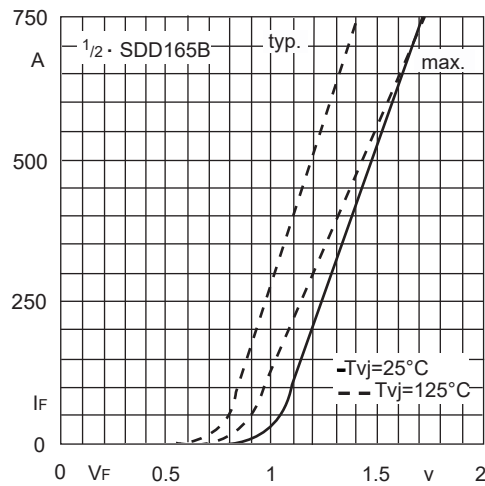

Fig.15 Forward characteristics

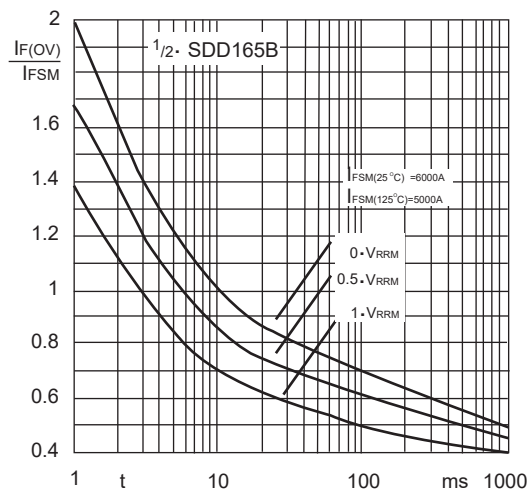

Fig.16 Surge overload current vs. time