

STD181GKXXB

Thyristor-Diode Modules

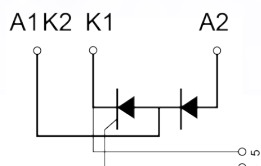

Type	V_{RSM} V_{DSM} V	V_{RRM} V_{DRM} V
STD181GK08B	900	800
STD181GK12B	1300	1200
STD181GK14B	1500	1400
STD181GK16B	1700	1600
STD181GK18B	1900	1800
STD181GK20B	2100	2000
STD181GK22B	2300	2200

Dimensions in mm (1mm=0.0394")

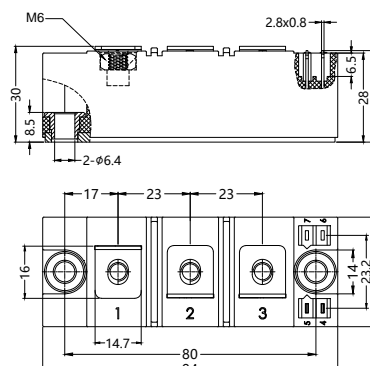

Symbol	Test Conditions	Maximum Ratings	Unit
I_{TRMS} , I_{FRMS} I_{TAVM} , I_{FAVM}	$T_{VJ}=T_{VJM}$ $T_C=85^{\circ}C$; 180° sine	300 181	A
I_{TSM} , I_{FSM}	$T_{VJ}=45^{\circ}C$ $V_R=0$ $t=10ms$ (50Hz), sine $t=8.3ms$ (60Hz), sine	6000 6400	A
	$T_{VJ}=T_{VJM}$ $V_R=0$ $t=10ms$ (50Hz), sine $t=8.3ms$ (60Hz), sine	5250 5600	
$\int i^2 dt$	$T_{VJ}=45^{\circ}C$ $V_R=0$ $t=10ms$ (50Hz), sine $t=8.3ms$ (60Hz), sine	180000 170000	A^2s
	$T_{VJ}=T_{VJM}$ $V_R=0$ $t=10ms$ (50Hz), sine $t=8.3ms$ (60Hz), sine	137000 128000	
$(di/dt)_{cr}$	$T_{VJ}=T_{VJM}$ $f=50Hz$, $t_p=200\mu s$ $V_D=2/3V_{DRM}$ $I_G=0.5A$ $di_G/dt=0.5A/\mu s$ repetitive, $I_T=500A$	150	A/ μs
	non repetitive, $I_T=I_{TAVM}$	500	
$(dv/dt)_{cr}$	$T_{VJ}=T_{VJM}$; $R_{GK}=\infty$; method 1 (linear voltage rise) $V_{DR}=2/3V_{DRM}$	1000	V/ μs
P_{GM}	$T_{VJ}=T_{VJM}$ $I_T=I_{TAVM}$ $t_p=30\mu s$ $t_p=500\mu s$	120 60	W
P_{GAV}		8	W
V_{RGM}		10	V
T_{VJ} T_{VJM} T_{stg}		-40...+125 125 -40...+125	$^{\circ}C$
V_{ISOL}	50/60Hz, RMS $I_{ISOL}\leq 1mA$ $t=1min$ $t=1s$	3000 3600	V~
M_d	Mounting torque (M6) Terminal connection torque (M6)	2.25-2.75/20-25 4.5-5.5/40-48	Nm/lb.in.
Weight	Typical	173	g

Sirectifier®

STD181GKXXB

Thyristor-Diode Modules

Symbol	Test Conditions	Characteristic Values	Unit
I_{RRM}, I_{DRM}	$T_{VJ}=T_{VJM}; V_R=V_{RRM}; V_D=V_{DRM}$	40	mA
V_T, V_F	$I_T, I_F=540A; T_{VJ}=25^{\circ}C$	1.65	V
V_{TO}	For power-loss calculations only ($T_{VJ}=T_{VJM}$)	0.8	V
r_T		1.6	m Ω
V_{GT}	$V_D=6V; T_{VJ}=25^{\circ}C$ $T_{VJ}=-40^{\circ}C$	2 2.6	V
I_{GT}	$V_D=6V; T_{VJ}=25^{\circ}C$ $T_{VJ}=-40^{\circ}C$	150 200	mA
V_{GD}	$T_{VJ}=T_{VJM}; V_D=2/3V_{DRM}$	0.25	V
I_{GD}	$T_{VJ}=T_{VJM}; V_D=2/3V_{DRM}$	10	mA
I_L	$T_{VJ}=25^{\circ}C; t_p=30\mu s; V_D=6V$ $I_G=0.45A; di_G/dt=0.45A/\mu s$	200	mA
I_H	$T_{VJ}=25^{\circ}C; V_D=6V; R_{GK}=\infty$	150	mA
t_{gd}	$T_{VJ}=25^{\circ}C; V_D=1/2V_{DRM}$ $I_G=0.5A; di_G/dt=0.5A/\mu s$	2	μs
t_q	$T_{VJ}=T_{VJM}; I_T=160A; t_p=200\mu s; -di/dt=10A/\mu s$ $V_R=100V; dv/dt=20V/\mu s; V_D=2/3V_{DRM}$	150	μs
Q_s	$T_{VJ}=T_{VJM}; I_T, I_F=300A; -di/dt=50A/\mu s$	550	μC
I_{RM}		235	A
R_{thJC}	per thyristor/diode; DC current per module	0.155 0.0775	K/W
R_{thJK}	per thyristor/diode; DC current per module	0.225 0.1125	K/W
d_s	Creeping distance on surface	12.7	mm
d_A	Creepage distance in air	9.6	mm
a	Maximum allowable acceleration	50	m/s ²

FEATURES

- * International standard package
- * Copper base plate
- * Glass passivated chips
- * Isolation voltage 3600 V~
- * UL file NO.E310749
- * RoHS compliant

APPLICATIONS

- * Motor control
- * Power converter
- * Heat and temperature control for industrial furnaces and chemical processes
- * Lighting control
- * Contactless switches

ADVANTAGES

- * Space and weight savings
- * Simple mounting
- * Improved temperature and power cycling
- * Reduced protection circuits



Sirectifier®

STD181GKXXB

Thyristor-Diode Modules

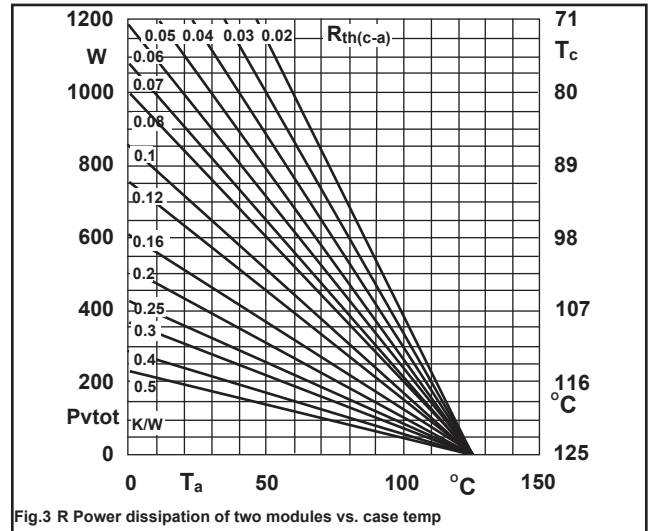
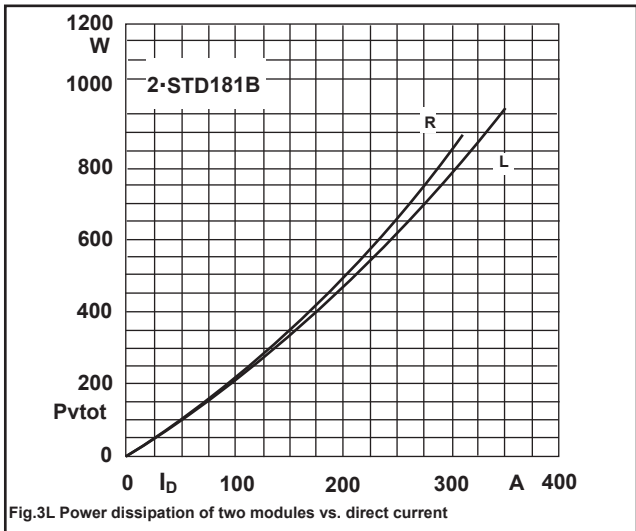
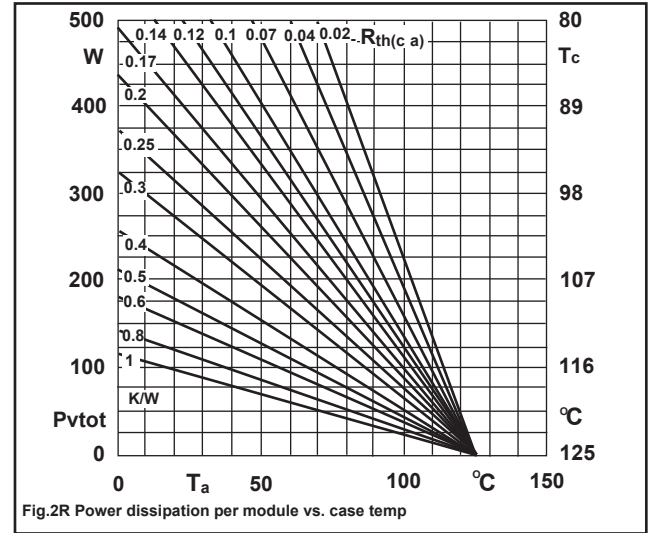
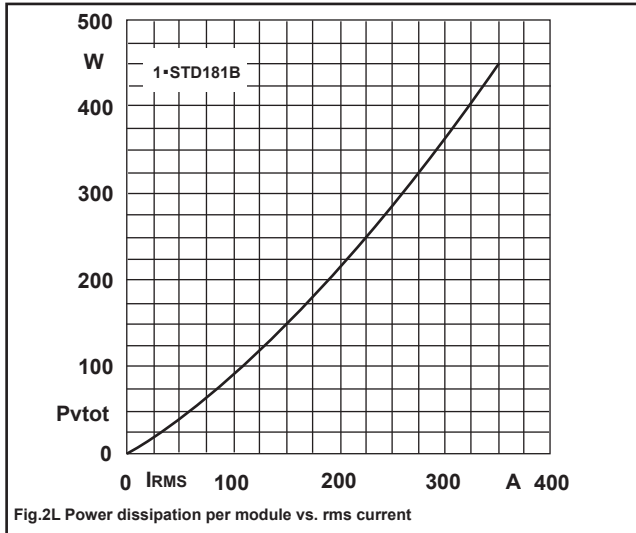
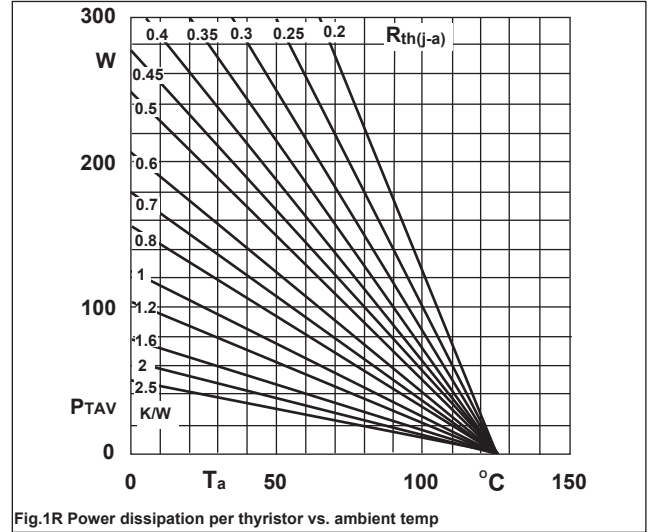
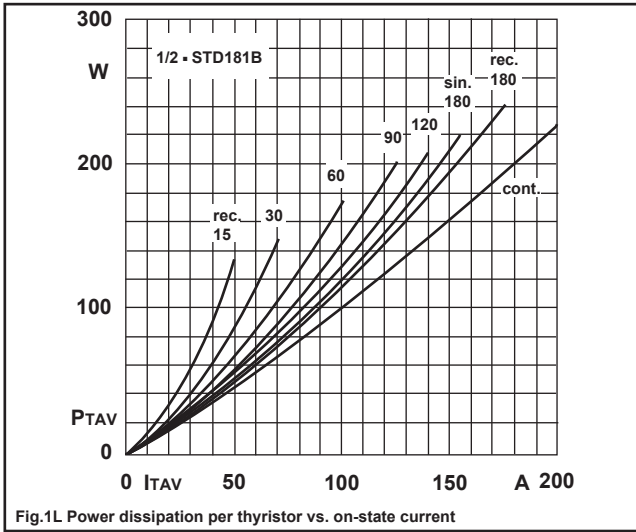

STD181GKXXB

Thyristor-Diode Modules

