

# STD90GKXX

## Thyristor-Diode Modules

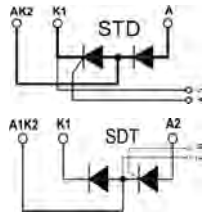

Type	$V_{RSM}$ $V_{DSM}$ V	$V_{RRM}$ $V_{DRM}$ V
STD90GK08	900	800
STD90GK12	1300	1200
STD90GK14	1500	1400
STD90GK16	1700	1600
STD90GK18	1900	1800
STD90GK20	2100	2000

Dimensions in mm (1mm=0.0394")

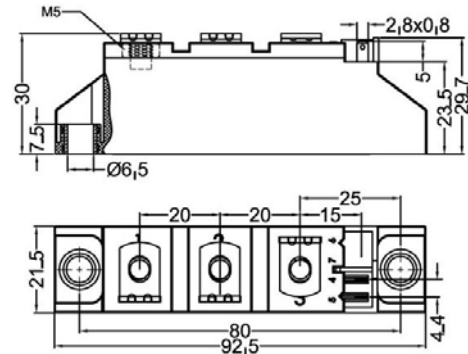

Symbol	Test Conditions	Maximum Ratings	Unit
$I_{TRMS}$ , $I_{FRMS}$ $I_{TAVM}$ , $I_{FAVM}$	$T_{VJ}=T_{VJM}$ $T_C=85^{\circ}C$ ; 180° sine	180 90	A
$I_{TSM}$ , $I_{FSM}$	$T_{VJ}=45^{\circ}C$ $V_R=0$ t=10ms (50Hz), sine t=8.3ms (60Hz), sine	1700 1800	A
	$T_{VJ}=T_{VJM}$ $V_R=0$ t=10ms(50Hz), sine t=8.3ms(60Hz), sine	1540 1640	
$\int i^2 dt$	$T_{VJ}=45^{\circ}C$ $V_R=0$ t=10ms (50Hz), sine t=8.3ms (60Hz), sine	14450 13500	A <sup>2</sup> s
	$T_{VJ}=T_{VJM}$ $V_R=0$ t=10ms(50Hz), sine t=8.3ms(60Hz), sine	11850 11300	
$(di/dt)_{cr}$	$T_{VJ}=T_{VJM}$ f=50Hz, $t_p=200\mu s$ $V_D=2/3V_{DRM}$ $I_G=0.45A$ $di_G/dt=0.45A/\mu s$ repetitive, $I_T=250A$	150	A/ $\mu s$
	non repetitive, $I_T=I_{TAVM}$	500	
$(dv/dt)_{cr}$	$T_{VJ}=T_{VJM}$ ; $R_{GK}=\infty$ ; method 1 (linear voltage rise) $V_{DR}=2/3V_{DRM}$	1000	V/ $\mu s$
$P_{GM}$	$T_{VJ}=T_{VJM}$ $I_T=I_{TAVM}$ $t_p=30\mu s$ $t_p=300\mu s$	10	W
		5	
$P_{GAV}$		0.5	W
$V_{RGM}$		10	V
$T_{VJ}$ $T_{VJM}$ $T_{stg}$		-40...+125	°C
		125	
		-40...+125	
$V_{ISOL}$	50/60Hz, RMS $I_{ISOL}\leq 1mA$ t=1min t=1s	3000	V~
		3600	
$M_d$	Mounting torque (M5) Terminal connection torque (M5)	2.5-4.0/22-35	Nm/lb.in.
		2.5-4.0/22-35	
Weight	Typical	78	g



# STD90GKXX

## Thyristor-Diode Modules

Symbol	Test Conditions	Characteristic Values	Unit
$I_{RRM}, I_{DRM}$	$T_{VJ}=T_{VJM}; V_R=V_{RRM}; V_D=V_{DRM}$	5	mA
$V_T, V_F$	$I_T, I_F=300A; T_{VJ}=25^{\circ}C$	1.74	V
$V_{TO}$	For power-loss calculations only ( $T_{VJ}=125^{\circ}C$ )	0.85	V
$r_T$		3.2	$m\Omega$
$V_{GT}$	$V_D=6V;$ $T_{VJ}=25^{\circ}C$ $T_{VJ}=-40^{\circ}C$	2.5 2.6	V
$I_{GT}$	$V_D=6V;$ $T_{VJ}=25^{\circ}C$ $T_{VJ}=-40^{\circ}C$	150 200	mA
$V_{GD}$	$T_{VJ}=T_{VJM}; V_D=2/3V_{DRM}$	0.2	V
$I_{GD}$		10	mA
$I_L$	$T_{VJ}=25^{\circ}C; t_p=10\mu s; V_D=6V$ $I_G=0.45A; di_G/dt=0.45A/\mu s$	450	mA
$I_H$	$T_{VJ}=25^{\circ}C; V_D=6V; R_{GK}=\infty$	200	mA
$t_{gd}$	$T_{VJ}=25^{\circ}C; V_D=1/2V_{DRM}$ $I_G=0.45A; di_G/dt=0.45A/\mu s$	2	$\mu s$
$t_q$	$T_{VJ}=T_{VJM}; I_T=150A; t_p=200\mu s; -di/dt=10A/\mu s$ $V_R=100V; dv/dt=20V/\mu s; V_D=2/3V_{DRM}$	185	$\mu s$
$Q_S$	$T_{VJ}=T_{VJM}; I_T, I_F=50A; -di/dt=6A/\mu s$	170	$\mu C$
$I_{RM}$		45	A
$R_{thJC}$	per thyristor/diode; DC current per module	0.3 0.15	K/W
$R_{thJK}$	per thyristor/diode; DC current per module	0.5 0.25	K/W
$d_s$	Creeping distance on surface	12.7	mm
$d_A$	Strike distance through air	9.6	mm
$a$	Maximum allowable acceleration	50	$m/s^2$

### FEATURES

- \* International standard package
- \* DCB base plate
- \* Glass passivated chips
- \* Isolation voltage 3600 V~
- \* UL File NO.E310749
- \* RoHS compliant

### APPLICATIONS

- \* DC motor control
- \* Softstart AC motor controller
- \* Light, heat and temperature control

### ADVANTAGES

- \* Space and weight savings
- \* Simple mounting with two screws
- \* Improved temperature and power cycling
- \* Reduced protection circuits



# STD90GKXX

## Thyristor-Diode Modules

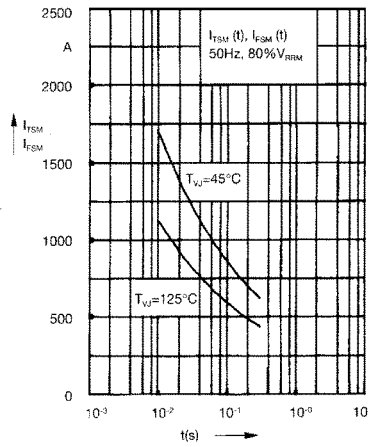

Fig. 1 Surge overload current  
 $I_{TSM}$ ,  $I_{FSM}$ : Crest value, t: duration

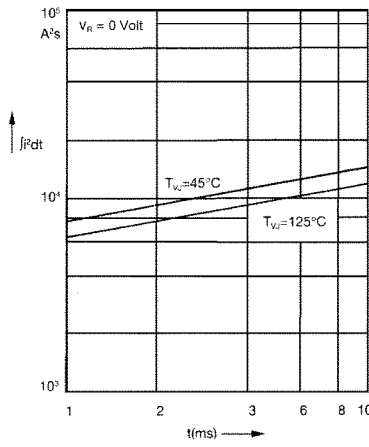

Fig. 2  $\int i^2 dt$  versus time (1-10 ms)

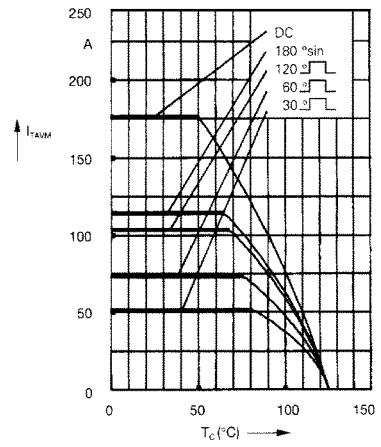

Fig. 2a Maximum forward current at case temperature

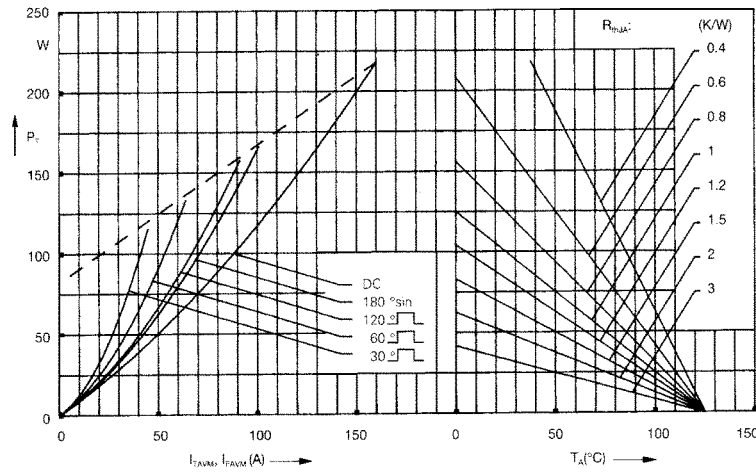

Fig. 3 Power dissipation versus on-state current and ambient temperature (per thyristor or diode)

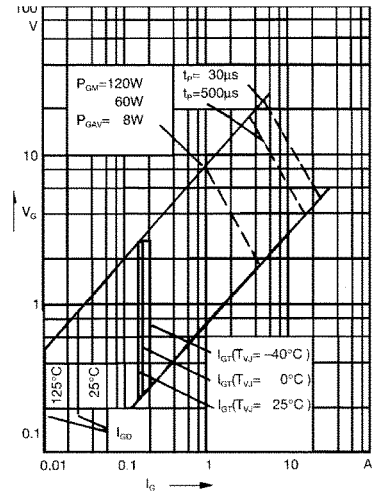

Fig. 4 Gate trigger characteristics

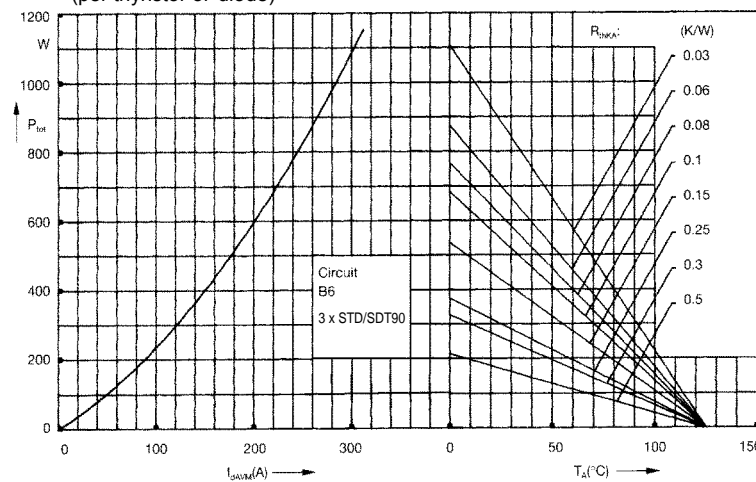

Fig. 5 Three phase rectifier bridge: Power dissipation versus direct output current and ambient temperature

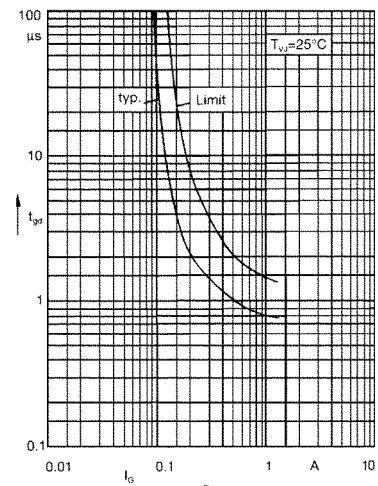

Fig. 6 Gate trigger delay time



# STD90GKXX

## Thyristor-Diode Modules

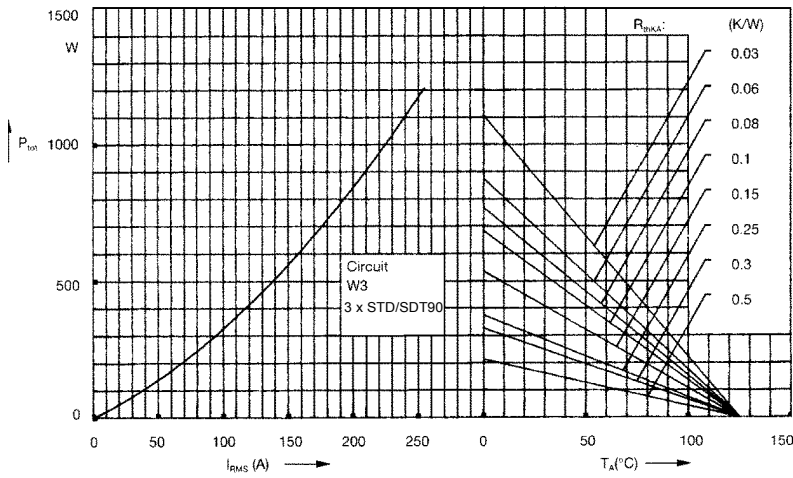

Fig. 7 Three phase AC-controller: Power dissipation versus RMS output current and ambient temperature

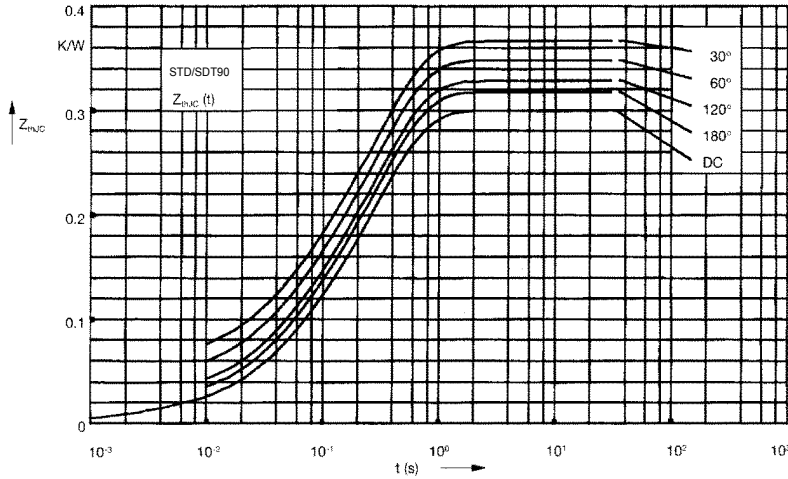

Fig. 8 Transient thermal impedance junction to case (per thyristor or diode)

$R_{thJC}$  for various conduction angles d:

d	$R_{thJC}$ (K/W)
DC	0.3
180 $^{\circ}C$	0.31
120 $^{\circ}C$	0.33
60 $^{\circ}C$	0.35
30 $^{\circ}C$	0.37

Constants for  $Z_{thJC}$  calculation:

i	$R_{thi}$ (K/W)	$t_i$ (s)
1	0.008	0.0019
2	0.054	0.047
3	0.238	0.3

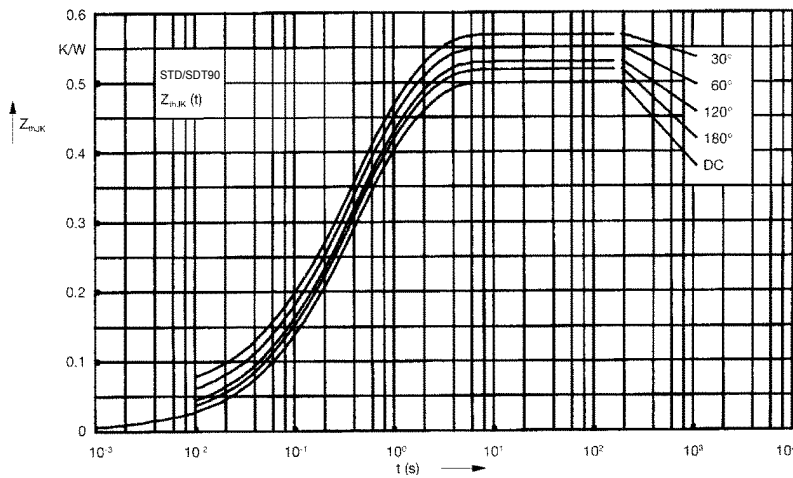

Fig. 9 Transient thermal impedance junction to heatsink (per thyristor or diode)

$R_{thJK}$  for various conduction angles d:

d	$R_{thJK}$ (K/W)
DC	0.5
180 $^{\circ}C$	0.51
120 $^{\circ}C$	0.53
60 $^{\circ}C$	0.55
30 $^{\circ}C$	0.57

Constants for  $Z_{thJK}$  calculation:

i	$R_{thi}$ (K/W)	$t_i$ (s)
1	0.008	0.0019
2	0.054	0.047
3	0.238	0.3
4	0.2	1.25

